

SEMI-EIXOS / HALF AXLES / DEMI ESSIEUX

SEMI-EIXOS COM SUSPENSÃO DE BORRACHA SEM TRAVÃO,
ACABAMENTO SUPERFICIAL DO TUBO ZINCADO

*RUBBER SUSPENSION HALF AXLES WITHOUT BRAKE,
SUPERFICIAL FINISHING OF TUBE COVERED WITH ZINC*

DEMI ESSIEUX AVEC SUSPENSIONS EN CAOUTCHOUC SANS FREIN,
FINITION SUPERFICIELLE DU TUBE ZINGUÉ

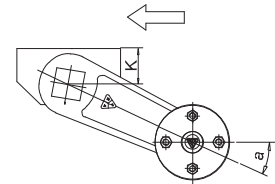
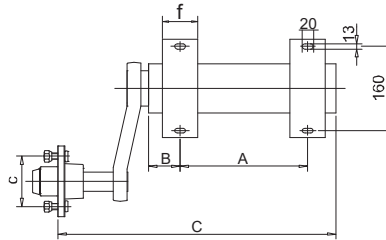

por par per pair pour paire		por par per pair pour paire		A	B	C	a	Øc	f	K	☐
Código/Code	Ref.	Kg	mm	mm	mm	mm	mm	mm	mm	mm	
*33 56 07	B-250.98/E	250	110	40	345	30°	98x4	50	55	6005 2RS-6204 2RS	
*33 56 10	B-450.98/E	450	200	45	410	30°	98x4	60	55	6005 2RS-6204 2RS	
33 56 17	B-250.98	250	110	40	355	30°	98x4	50	55	6005 2RS-6204 2RS	
33 56 20	B-450.98	450	200	45	420	30°	98x4	60	55	6005 2RS-6204 2RS	

* EQUIPADO COM CUBO ESTANQUE / EQUIPPED WITH TIGHT HUB / ÉQUIPÉ AVEC MOYEU ÉTANCHE





EIXOS SEM TRAVÃO / NON BRAKED AXLES / ESSIEUX SANS FREIN

EIXOS COM SUSPENSÃO DE BORRACHA SEM TRAVÃO,
ACABAMENTO SUPERFICIAL DO TUBO ZINCADO

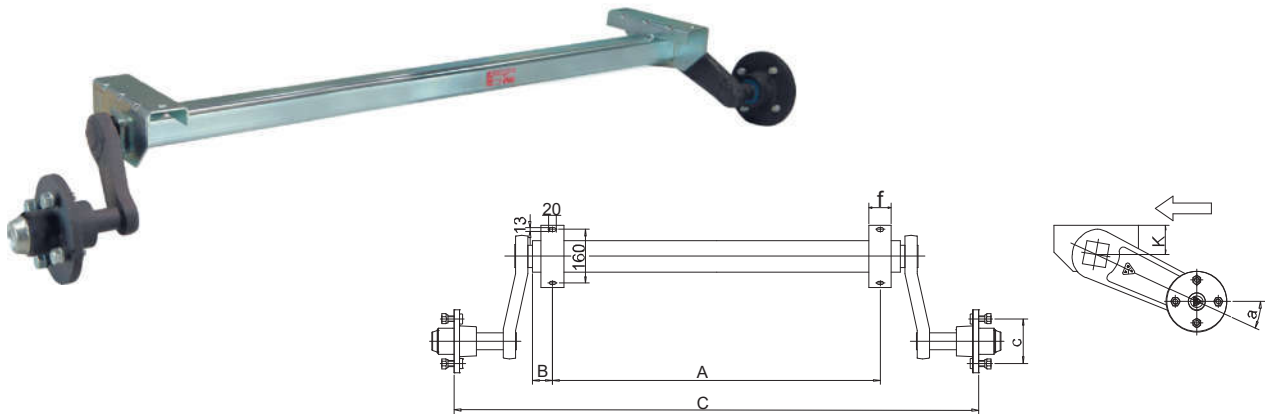
NON-BRAKED RUBBER SUSPENSION AXLES,
SUPERFICIAL FINISHING OF THE TUBE COVERED WITH ZINC

ESSIEUX ROUTIERS À SUSPENSION EN CAOUTCHOUC
SANS FREIN, FINITION SUPERFICIELLE DU TUBE ZINGUÉ

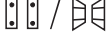

			A	B	C	a	Øc	f	K	 / 
Código/Code	Ref.	Kg	mm	mm	mm		mm	mm	mm	
33 90 05	EX-350.98	350	895	35	1235	30°	98x4	50	55	6005 2RS-6204 2RS
*33 90 12	EX-350.98/E	350	1160	40	1500	30°	98x4	50	55	6005 2RS-6204 2RS
33 90 15	EX-350.98	350	1160	35	1500	30°	98x4	50	55	6005 2RS-6204 2RS
33 90 19	EX-450.98	450	1310	35	1650	30°	98x4	60	55	6005 2RS-6204 2RS
*33 90 21	EX-450.98/E	450	1310	40	1650	30°	98x4	60	55	6005 2RS-6204 2RS
33 90 23	EX-600.98	600	1340	35	1685	30°	98x4	60	55	30205-30203
33 90 26	EX-750.98	750	1200	40	1570	30°	98x4	50	58	30205-32004
33 90 31	EX-1000.98	1000	1530	55	1935	25°	98x4	60	65	32006-32004
33 90 39	EX-1500.140	1500	1530	60	1935	25°	140x5	60	65	32206- 30204

* EQUIPADO COM CUBO ESTANQUE / EQUIPPED WITH TIGHT HUB / ÉQUIPÉ AVEC MOYEU ÉTANCHE

Sob pedido, outras dimensões / Under request, others dimensions / Sous demande, autres dimensions









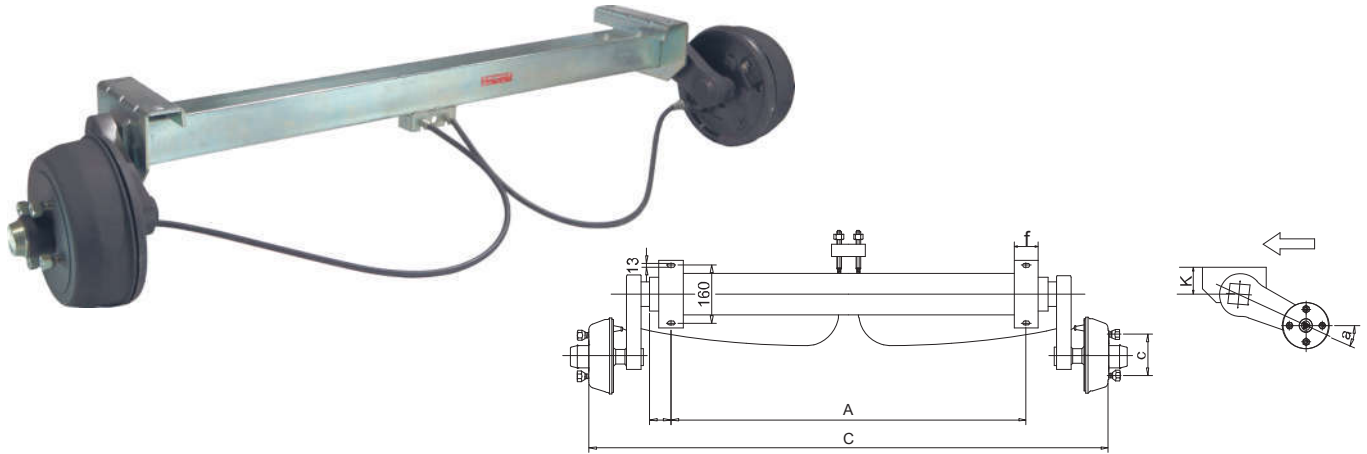

EIXOS COM TRAVÃO / AXLES WITH BRAKED / ESSIEUX AVEC FREIN

EIXOS COM SUSPENSÃO DE BORRACHA COM TRAVÃO
RETROMARCHA PARA REBOQUES MAIS DE 25 KM/H,
ACABAMENTO SUPERFICIAL DO TUBO ZINCADO

*RUBBER SUSPENSION AXLES WITH BRAKE
FOR TRAILERS OVER 25 KM/H,
SUPERFICIAL FINISHING OF TUBE COVERED WITH ZINC*

ESSIEUX ROUTIERS À SUSPENSION EN CAOUTCHOUC AVEC FREIN
POUR REMORQUES À PLUS 25 KM/H,
FINITION SUPERFICIELLE DU TUBE ZINGUÉ



				A	C	a	Øc	f	K	
Código/Code	Ref.	Kg	mm	mm	mm		mm	mm	mm	
33 90 81	EX-750.98/TTR-DP	750	Ø160x35	-	-	30°	98x4	50	55	
33 90 84	EX-1000.98/TTR-DP	1000	Ø160x35	-	-	30°	98x4	50	55	
33 90 77	EX-1150x112x5/TTR	1150	Ø200x50	-	-	25°	112x5	50	55	
33 90 78	EX-1350x112x5/TTR	1350	Ø200x50	-	-	25°	112x5	50	55	
33 90 79	EX-1500x112x5/TTR	1500	Ø200x50	-	-	25°	112x5	50	55	
33 90 80	EX-1800x112x5/TTR	1800	Ø250x40	-	-	25°	112x5	60	65	

Dimensões A, C sob pedido
Under request, dimensions A, C
Dimensions A, C sous demande