

ESFERA PARA ENGATES (Ø50 - ISO 1103)

TOW BALL (Ø50 - ISO 1103)

ROTULE (Ø50 - ISO 1103)

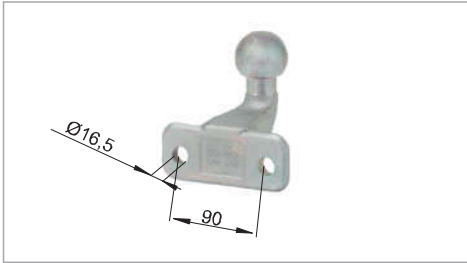

| Código/Code | Ref.   |     |      |
|-------------|--------|-----|------|
|             |        | Kg  | Kg   |
| 33 50 02    | E-50/1 | 350 | 3500 |



| Código/Code | Ref.  |     |    |
|-------------|-------|-----|----|
|             |       | Kg  | Kg |
| 33 50 04    | EM-50 | 250 | *  |

\*eixo 3500  
\*esfera 1500

PROTECTOR ESFERA (Ø50)

TOW BALL COVER (Ø50)

CACHE ROTULE (Ø50)



REF.: PROTECTOR: PE.50/1

| Código/Code |
|-------------|
| 33 50 11    |

ENGATES DE ESFERA SEM TRAVAO

COUPLINGS FOR NON-BRAKED TRAILERS

CROCHETS TÊTE D'ATTELAGE SANS FREIN



| Código/Code | Ref.           | A  | Ød | B  |     |      |
|-------------|----------------|----|----|----|-----|------|
|             |                |    |    |    | Kg  | Kg   |
| 33 26 03    | EE-50/750-Ø50  | 90 | 13 | 51 | 75  | 750  |
| 33 26 05    | EE-50/1400-Ø60 | 90 | 13 | 61 | 100 | 1400 |



| Código/Code | Ref.           | FIG | B  |     |      |
|-------------|----------------|-----|----|-----|------|
|             |                |     |    | Kg  | Kg   |
| 33 26 04    | EE-50/1300-Ø45 | 1   | 45 | 100 | 1300 |
| 33 26 11    | EE-50/2700-Ø50 | 2   | 50 | 150 | 3000 |
| 33 26 12    | EE-50/3500-Ø60 | 2   | 60 | 150 | 3500 |



| Código/Code | Ref.        | ØB |     |      |
|-------------|-------------|----|-----|------|
|             |             |    | Kg  | Kg   |
| 33 26 15    | EA-2000-Ø45 | 45 | 100 | 2000 |
| 33 26 16    | EA-2700-Ø50 | 50 | 150 | 2700 |
| 33 26 17    | EA-3500-Ø60 | 60 | 150 | 3500 |

ENGATES DE INÉRCIA COM TRAVÃO (VEL. >25 Km / h)

HYDRAULICALLY DAMPED OVERRUN-BRAKED COUPLINGS (Speed >25 Km / h)

COMMANDE DE FREIN AVEC ATTACHES À INERTIE (VEL. >25 Km / h)

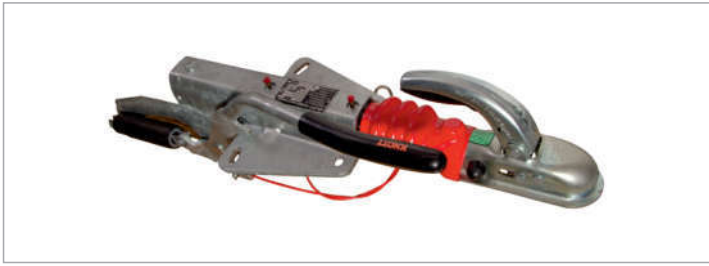

| Código/Code | Ref.       | Kg  | Kg   |      |
|-------------|------------|-----|------|------|
|             |            |     | min. | max. |
| 33 91 01    | TI-50/1200 | 100 | 750  | 1200 |
| 33 91 12    | TI-50/1300 | 100 | 750  | 1300 |
| 33 91 05    | TI-50/1700 | 100 | 800  | 1700 |
| 33 91 04    | TI-50/2000 | 100 | 1100 | 2000 |
| *33 91 08   | TI-50/2700 | 150 | 1400 | 2700 |

| Código/Code | Ref.       | Kg  | Kg   |      |
|-------------|------------|-----|------|------|
|             |            |     | min. | max. |
| 33 91 10    | TI-50/3000 | 150 | 1600 | 3000 |
| 33 91 07    | TI-50/3500 | 350 | 2700 | 3500 |

\*CABEÇA EM FUNDIÇÃO / CAST IRON COUPLING / TÊTE D'ATTELAGE EN FONTE

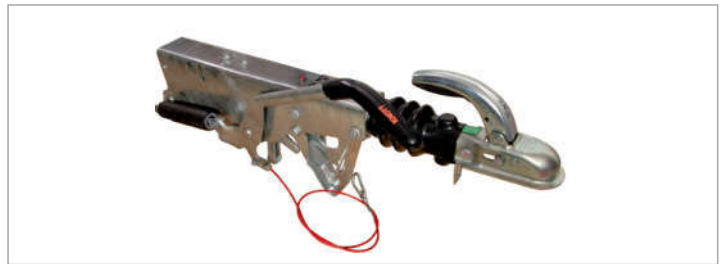

| Código/Code | Ref.       | Kg  | Kg   |      |
|-------------|------------|-----|------|------|
|             |            |     | min. | max. |
| 33 91 15    | TI-50/1300 | 100 | 750  | 1300 |
| 33 91 16    | TI-50/2000 | 100 | 1100 | 2000 |
| 33 91 17    | TI-50/2700 | 150 | 1400 | 2700 |

| Código/Code | Ref.           | Kg  | Kg   |      | Ø   |
|-------------|----------------|-----|------|------|-----|
|             |                |     | min. | max. |     |
| 33 91 22    | TI-50/1300Ø60  | 100 | 750  | 1300 | 60  |
| 33 91 21    | TI-50/2000Ø80  | 100 | 1100 | 2000 | 80  |
| *33 91 23   | TI-50/3000Ø100 | 150 | 1600 | 3000 | 100 |
| *33 91 24   | TI-50/3500Ø120 | 350 | 2700 | 3500 | 120 |

\*CABEÇA EM FUNDIÇÃO / CAST IRON COUPLING / TÊTE D'ATTELAGE EN FONTE

RODAS JOCKEY  
 JOCKEY WHEELS  
 ROUES JOCKEY

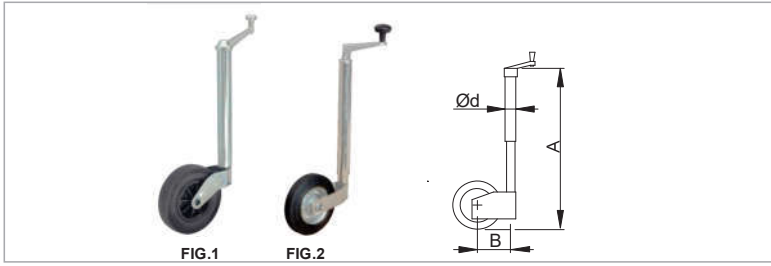

| Código/Code | Ref.            | FIG | mm  | A min. | A max. | Ød | B   | Kg  |
|-------------|-----------------|-----|-----|--------|--------|----|-----|-----|
| 23 54 14    | 202/BNES/35-160 | 2   | 160 | 45     | 430    | 35 | 120 | 80  |
| 23 54 17    | 202/BNES/48-200 | 2   | 200 | 50     | 500    | 48 | 160 | 100 |
| 23 54 16    | 202/BSA/43-200  | 1   | 200 | 50     | 520    | 43 | 145 | 150 |

ABRAÇADEIRA  
 CLAMP  
 COLLIER

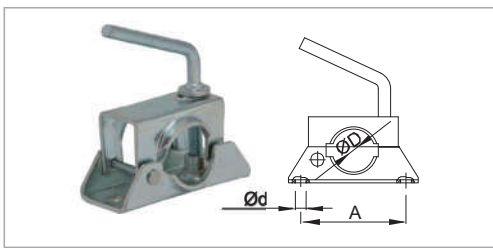

| Código/Code | Ref.  | ØD | A   | Ød   |
|-------------|-------|----|-----|------|
| 33 91 50    | AB-35 | 35 | 105 | 10,5 |
| 33 91 51    | AB-43 | 43 | 105 | 10,5 |
| 33 91 52    | AB-48 | 48 | 105 | 10,5 |

MACACOS  
 CORNER STEADIES  
 BRAS DE SUPPORT

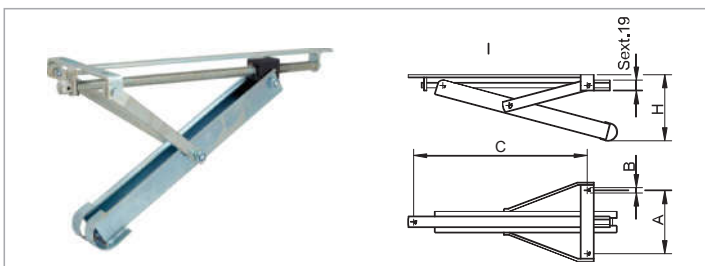

| Código/Code | Ref.               | Kg   | A mm | ØB mm | C mm | H(Máx.) mm |
|-------------|--------------------|------|------|-------|------|------------|
| 33 00 03    | MA-138.442 - M16x4 | 200  | 138  | 11    | 442  | 415        |
| 33 00 04    | MA-138.530 - M16x4 | 300  | 138  | 11    | 530  | 490        |
| 33 00 05    | MA-215.600         | 1100 | 215  | 13    | 600  | 495        |

RODAS JOCKEY  
 JOCKEY WHEELS  
 ROUES JOCKEY

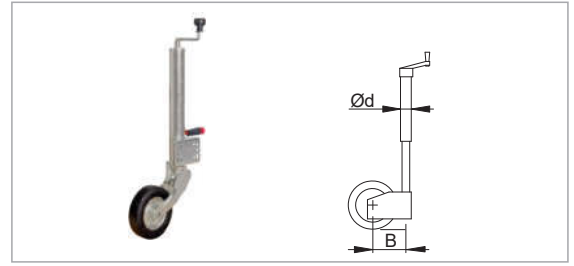

| Código/Code | Ref.            | mm  | d  | Kg  |     |
|-------------|-----------------|-----|----|-----|-----|
| 23 54 18    | 202/BNES/60-220 | 220 | 65 | Ø60 | 250 |

SAPATA  
 TRAILER JACK  
 BÉQUILLE



| Código/Code | Ref.       | FIG. | Kg   |
|-------------|------------|------|------|
| 60 60 42    | SAPATA-Ø60 | 1    | 800  |
| 60 60 41    | SAPATA-Ø70 | 2    | 1500 |

MANIVELA  
 BRACE  
 MANIVELLE

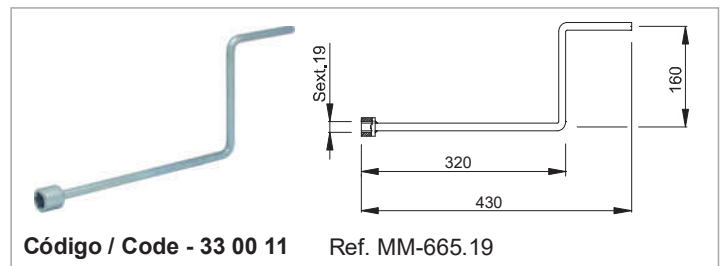

Código / Code - 33 00 11 Ref. MM-665.19

COMPONENTES PARA ATRELADOS DE BARCOS OU SIMILARES

COMPONENTS FOR BOAT TRAILERS OR SIMILAR

PIÈCES POUR REMORQUES DE BATEAUX OU SIMILAIRES

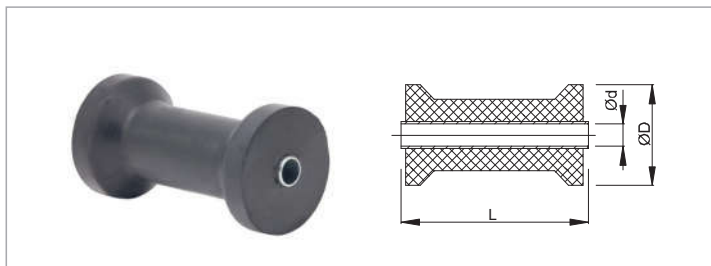

| Código/Code | Ref.         | ØD<br>mm | L<br>mm | Ød<br>mm |
|-------------|--------------|----------|---------|----------|
| 39 52 01    | BN-70x125.16 | 70       | 126     | 16       |
| 39 52 04    | BN-80x150.16 | 80       | 157     | 16       |

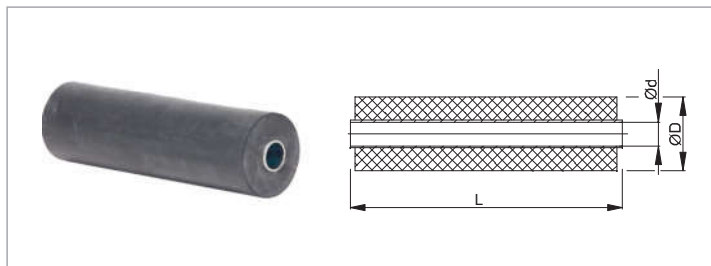

| Código/Code | Ref.         | ØD<br>mm | L<br>mm | Ød<br>mm |
|-------------|--------------|----------|---------|----------|
| 39 52 02    | BN-50x175.16 | 50       | 178     | 16       |

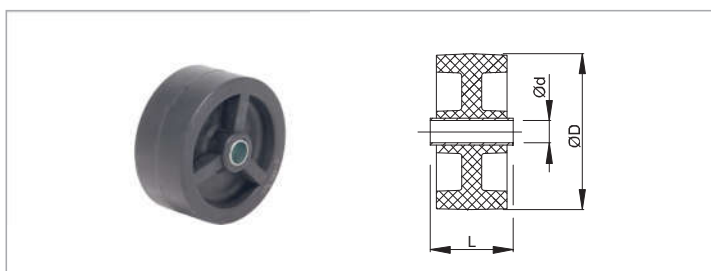

| Código/Code | Ref.         | ØD<br>mm | L<br>mm | Ød<br>mm |
|-------------|--------------|----------|---------|----------|
| 39 52 00    | BN-110x50.16 | 110      | 58      | 16       |

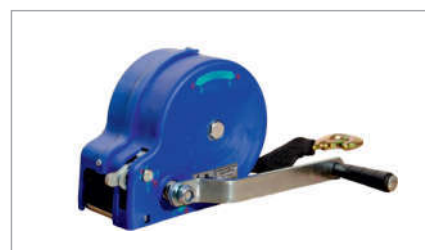

| Código/Code | Ref.            | Kg   |
|-------------|-----------------|------|
| 60 60 08    | GUINCHO 450 KG  | 450  |
| 60 60 09    | GUINCHO 1150 KG | 1150 |



GUARDA - LAMAS

FENDER

GARDE - BOUES



| Código/Code | Ref.                             | A<br>mm | B<br>mm | C<br>mm |
|-------------|----------------------------------|---------|---------|---------|
| 60 60 46    | Guarda - Lamas Plast. PR - 10''  | 620     | 240     | 180     |
| 60 60 48    | Guarda - Lamas Plast. PR - 13''  | 770     | 335     | 200     |
| *60 60 53   | Guarda - Lamas Plast. AZ - 14''  | 790     | 370     | 220     |
| 60 60 52    | Guarda - Lamas Plast. PR -2x14'' | 1550    | 400     | 240     |

\*AZUL / BLUE / BLEU

SOB PEDIDO GUARDA LAMAS GALVANIZADO

PLACA DE SINALIZAÇÃO

LIGHT BOARD TOWING

PLAQUE D'ÉCLAIRAGE

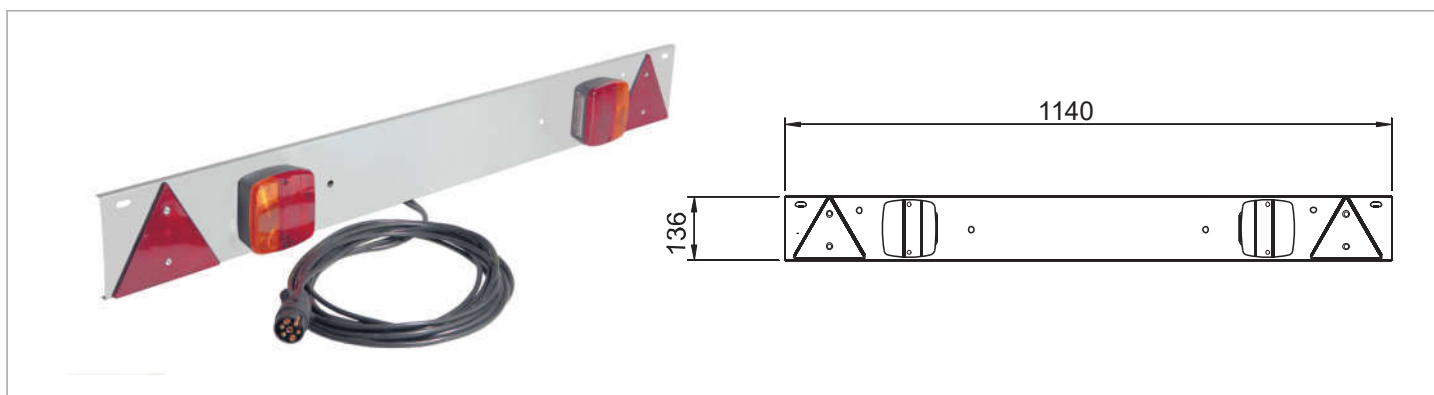

| Código/Code | Ref.                       |
|-------------|----------------------------|
| 33 09 02    | Placa Sinal. c/ Kit Elect. |

- CHAPA METÁLICA PINTADA
- CABOS 4 METROS
- CONJUNTO COM 4 FUNÇÕES
- METTALIC PLATE PAINTED
- 4 METERS CONNEXION CABLE
- MULTIFUNCTION
- PLAQUE MÉTALLIQUE PEINTE
- CÂBLE DE 4 MÈTRES
- ENSEMBLE À 4 FONCTIONS